

P8000

P8000
3/12-Channel ECG Unit



Art.-no.: 974040041 Rev.: a

User Guide

ESAOOTE



Sales and Service Information

The ESAOTE sales and service centre network is world-wide. For the address of your local distributor, contact your nearest ESAOTE subsidiary. In case of difficulty a complete list of all distributors and subsidiaries is provided on our internet site: <http://www.esaote.com>

Distributed by:

ESAOTE S.P.A
Via Di Caciolle 15
50127 Firenze, Italia

Tel: +39 055 4229 1
Fax: +39 055 4229 208
web:www.esaote.com

Manufactured by:

SCHILLER AG
Altgasse 68
CH-6341 Baar, Switzerland
Web:

Phone: +41 (0) 41 766 42 42
Fax: +41 (0) 41 761 08 80,
E-mail: sales@schiller.ch
www.schiller.ch

Contents

1	Safety notes	3
1.1	Responsibility of the User	3
1.2	Intended Use	3
1.3	Organisational Measures	3
1.4	Safety-conscious Operation	4
1.5	Safety Facilities	4
1.6	Operation with other Devices	5
1.7	Maintenance	5
1.8	Safety Symbols and Pictograms	6
1.9	Terms of Warranty	7
2	Introduction	8
2.1	Features	8
2.1.1	Standard Features	8
2.1.2	Optional Features	8
2.2	Operating Philosophy Overview	9
2.2.1	Initiating Functions or Tasks	9
2.2.2	Main Components of the P8000	10
2.2.3	Back Panel	10
2.3	Keypad	11
2.4	LCD Screen	13
3	Operation	14
3.1	Start-up and Initial Preparation	14
3.1.1	Connecting P8000	14
3.1.2	Battery Operation	15
3.1.3	Switching ON and OFF	15
3.1.4	Isolating the Mains Supply	15
3.1.5	Potential Equalisation	15
3.1.6	Inserting Printing Paper	16
3.1.7	LCD contrast adjustment	16
3.2	Entering Patient Data	17
4	Resting ECG	18
4.1	Electrode Placement	18
4.2	Further Lead Combinations	20
4.2.1	Nehb Leads	20
4.2.2	Electrode Positions for Additional Leads	21
4.2.3	Electrodes and Neutral Electrodes Identification and Colour Code	22
4.3	Skin/Electrode Resistance	23
4.3.1	High Electrode Resistance Indication	23
4.3.2	Electrode and Patient cable Check (Lead Test)	23
4.4	Modes of Operation and Procedural Overview	24
4.4.1	Automatic Mode	25

4.4.2	Manual Mode	26
4.4.3	Screen (and Manual Printout) Settings	27
4.5	Memory (option).....	29
4.5.1	Transmitting the Recordings	30
5	Setup	31
5.1	Entering the SETUP Menu	31
5.1.1	Navigating in the Setup Screens.....	31
5.2	ECG Settings.....	32
5.2.1	Automatic Format 1 and 2 Internal Printer	33
5.2.2	Automatic Format 1 and 2 External Printer	34
5.2.3	Filters	35
5.2.4	Interpretation (Only with version C)	36
5.2.5	Leads	37
5.2.6	General (only with version m = Memory)	37
5.3	System Settings.....	38
5.3.1	Unit.....	39
5.3.2	Communication	40
5.3.3	Test and Information	41
5.3.3.1	Print Setup	42
5.3.3.2	Communications Test	43
5.3.3.3	Installing New Software Options (Upgrade).....	43
5.3.3.4	Update the Software	43
5.3.3.5	Default Settings.....	44
6	Care & Maintenance	45
6.1	Communication (RS-232) Test.....	45
6.2	12 Monthly Check	45
6.3	Maintenance interval for the battery	46
6.3.1	Charging the battery	46
6.3.2	Battery disposal	46
6.4	Changing the fuse and mains voltage	47
6.5	Cleaning.....	48
6.5.1	Cleaning the Casing.....	48
6.5.2	Cleaning the Patient Cable	48
6.5.3	Cleaning the Thermal Print Head.....	48
6.6	Replacing the Recording Paper	49
6.6.1	Thermal Paper Handling	49
6.7	Fault-Finding	50
6.7.1	Accessories and Disposables	51
7	Technical Data	52
7.1	System	52
7.2	Technical Data for ECG.....	53
7.3	Safety Standards	54
8	Index	55

1 Safety notes

1.1 Responsibility of the User



- ▲ This device must only be used by qualified doctors or trained medical personnel.
- ▲ The numerical and graphical results and any interpretation given must be examined with respect to the overall clinical condition of the patient and the general recorded data quality.
- ▲ The indications given by this equipment are not a substitute for regular checking of vital functions.
- ▲ Specify the competencies of the personnel for operation and repair.
- ▲ Ensure that personnel have read and understood these operating instructions. In particular this chapter "safety notes" must be read and understood.
- ▲ Have damaged or missing components replaced immediately.
- ▲ The operator is responsible for compliance with all applicable accident prevention regulations and safety regulations.

1.2 Intended Use



- ▲ The P8000 is a 3/12-channel, ECG device used for the recording, analysis and evaluation of ECG Recordings. Recordings made with the P8000 can be used as a diagnostic aid for heart function and heart conditions. The P8000 is designed for indoor use and can be used for all patients of both sexes, all races, and all ages.
- ▲ There is no danger for patients with pacemaker.
- ▲ Only operate the device in accordance with the specified technical data.
- ▲ The system is **not** designed for sterile use nor is it designed for outdoor use.
- ▲ Do **not** use this unit in areas where there is any danger of explosion or in the presence of flammable gases such as anaesthetic agents.
- ▲  This unit is CF classified and defibrillation protected only when the original patient cable is used. However, as a safety precaution when possible, remove electrodes before defibrillation.
- ▲ This product is not designed for internal use. This product is not designed for direct cardiac application.

1.3 Organisational Measures



- ▲ Before using the unit, ensure that an introduction regarding the unit functions and the safety precautions has been provided by a medical product representative.
- ▲ Keep these operating instructions in an accessible place for reference when required. Make sure that they are always complete and legible.
- ▲ Observe the operating instructions and maintenance instructions.
- ▲ These operating instructions do not override any statutory or local regulations, or procedures for the prevention of accidents and environmental protection.

1.4 Safety-conscious Operation



- ▲ Make sure that the staff has read and understood the operating instructions - particularly the "Safety Notes" chapter.
- ▲ Do not touch the unit casing during defibrillation.
- ▲ It must be ensured that neither the patient nor the electrodes (including the neutral electrode) come into contact with other conducting objects (even if these are earthed).
- ▲ Immediately report any changes that impair safety (including operating behaviour) to the person responsible.
- ▲ Do not place any liquids on the unit. If liquid should be spilled over the device, immediately disconnect the device from the mains and wipe it. The device must be serviced before reusing.

1.5 Safety Facilities



- ▲ Operating the device without the correctly rated fuse, or with defective cables, constitutes a danger to life. Therefore:
 - Do not operate the unit if the earth connection is suspect or if the mains lead is damaged or suspected of being damaged.
 - Damaged cable connections and connectors must be replaced immediately.
 - The electrical safety devices, such as fuses, must not be altered.
 - Ruptured fuses must only be replaced with the same type and rating as the original.

1.6 Operation with other Devices



- ▲ Use only accessories and other parts recommended or supplied by ESAOTE. Use of other than recommended or supplied parts may result in injury, inaccurate information and/or damage to the unit.
- ▲ Ancillary equipment connected to the analogue and/or digital interfaces must be certified according to the respective IEC standards (e.g. IEC/EN 60950 for data processing equipment and IEC/EN 60601-1 for medical equipment). Furthermore all configurations shall comply with the valid version of the system standard IEC/EN 60601-1-1. Everybody who connects additional equipment to the signal input part or signal output part configures a medical system, and is therefore responsible that the system complies with the requirements of the valid version of the system standard IEC/EN 60601-1-1. If in doubt, consult the technical service department or your local representative.
 - EC/EN 60601-1-1 states that the patient must remain at least 1.5 meters clear of the unit. If this is not possible, a safety isolating transformer must be installed.
- ▲ Any other equipment used with the patient must use the same common earth as the P8000.
- ▲ Precautions must be observed when using high frequency devices. Use the special high frequency ESAOTE patient cable to avoid possible signal interference during ECG acquisition.
- ▲ There is no danger when using the ECG unit simultaneously with electrical stimulation equipment. However, the stimulation units should only be used at a sufficient distance from the electrodes. If in doubt, the patient should be disconnected from the monitor.
- ▲ If the patient cable should become defective after defibrillation, an electrode becomes displaced, or an electrode resistance is too high, a lead-off indication is displayed in the upper right part of the screen and an acoustic alarm given.

1.7 Maintenance



- ▲ Danger of electric shock! Do not open the device. No serviceable parts inside. Refer servicing to qualified personnel only.
- ▲ Before cleaning and to isolate the mains power supply, switch the unit off and disconnect it from the mains by removing the plug.
- ▲ Do not use high temperature sterilisation processes (such as autoclaving). Do not use E-beam or gamma radiation sterilisation.
- ▲ Do not use solvent or abrasive cleaners on either the unit or cable assemblies.
- ▲ Do not, under any circumstances, immerse the unit or cable assemblies in liquid.

1.8 Safety Symbols and Pictograms

The safety level is classified according ANSI Z535.4. The following overview shows the used safety symbols and pictograms used in this manual.



For a direct danger which could lead to severe personal injury or to death.



For a possibly dangerous situation, which could lead to heavy bodily injury or to death.



For a possibly dangerous situation which could lead to personal injury. This symbol is also used to indicate possible damage to property.



For general safety notes as listed in this chapter.



Used for electrical dangers, warnings and other notes in regarding operation with electricity.



Note For possibly dangerous situations, which could lead to damages to property or system failure.

Important or helpful user information



Reference to other guidelines



Potential equalization



CF symbol. This unit is classified safe for internal and external use. However, It is only defibrillation protected when used with the original ESAOTE patient cable!



The unit/component can be recycled.

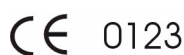

Notified body of the CE certification (TÜV P.S.)

1.9 Terms of Warranty

The ESAOTE P8000 is warranted against defects in material and manufacture for the duration of one year (as from date of purchase). Excluded from this guarantee is damage caused by an accident or as a result of improper handling. The warranty entitles free replacement of the defective part. Any liability for subsequent damage is excluded. The warranty is void if unauthorized or unqualified persons attempt to make repairs.

In case of a defect, send the apparatus to your dealer or directly to the manufacturer. The manufacturer can only be held responsible for the safety, reliability, and performance of the apparatus if:

- assembly operations, extensions, readjustments, modifications, or repairs are carried out by persons authorized by him, and
- the ESAOTE P8000 and approved attached equipment is used in accordance with the manufacturers instructions.



There are no Express or implied warranties which extend beyond the warranties hereinabove set forth. ESAOTE makes no warranty of merchantability or fitness for a particular purpose with respect to the product or parts thereof.



This equipment has been tested and found to comply with the limits for a class A digital device, pursuant to both Part 15 of the FCC (Federal Communications Commission) Rules and the radio interference regulations of the Canadian Department of Communications. These limits are designed to provide reasonable protection against harmful interference when the equipment is operated in a commercial environment. This equipment generates, uses and can radiate radio frequency energy and, if not installed and used in accordance with this instruction manual, may cause harmful interference to radio communications. Operation of this equipment in a residential area is likely to cause harmful interference in which case the user will be required to correct the interference at his own expense.

2 Introduction

2.1 Features

The ESAOTE P8000 is a 3/12-channel ECG unit designed to record, display, and analyse resting ECGs. The unit has been extensively researched to give an ergonomic, clear interface that's easy to use without compromising functionality. The P8000 has the following features:

2.1.1 Standard Features

- Alphanumeric keypad and dedicated soft key interface for easy, user friendly operation.
- Integral thermal quality printer with various user defined print format options.
- Measurements and average cycles with automatic and manual printout of the recording.

2.1.2 Optional Features

- External printer
- ECG Interpretation
- Memory for up to 40 recordings
- Thrombolysis

2.2 Operating Philosophy Overview

There are broadly four types of data display as follows:

Data Acquisition and ECG Recording Screen

In this screen the real-time ECG is displayed. From this screen a continuous printout can be initiated and/or an auto recording can be made. In auto mode 10 seconds of ECG data is analysed and averaged and the results given on a printout. The format and data of an auto mode printout is independent of the screen display and is defined in the setup screens. (See paragraph 5.2 page 32).

An auto mode recording can also be stored in the memory for later print or transmission.

Memory Screen

In this screen stored recordings can be accessed, printed and transmitted.

Patient Data Screen

Patient data entry via the keypad.

Data Entry and Setup

In these screens all system settings are made.

2.2.1 Initiating Functions or Tasks

Most functions and tasks are initiated by the 5 softkeys (1) situated immediately below the LCD. The function of the softkeys varies according to the screen displayed and is displayed on the LCD immediately above the key itself.

During data acquisition, further dedicated function keys are provided to make an auto mode recording (START) and to stop a manual printout (STOP). The top line of the alphanumeric keypad, additionally enables direct settings of lead group, trace speed and sensitivity, filter on/off and other functions, for both the real-time display and (manual) printout.

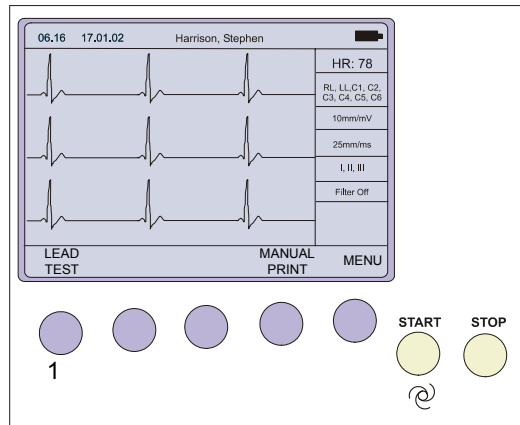

Fig. 2.1 Start-up screen

2.2.2 Main Components of the P8000

- (1) LCD Display
- (2) Softkey control
- (3) Keypad and dedicated function keys
- (4) Printer



2.2.3 Back Panel



▲ All externally connected hardware must be approved by ESAOTE. Connection of any hardware not approved by ESAOTE is at the owner's risk. The unit warranty may also be invalid. See also safety note paragraph 1.6.

- (1) Patient cable connector
- (2) LPT connector for the connection of an external printer
- (3) RS-232 for connection of a modem or a PC for export of stored recordings
- (4) Mains connector (with fuse above)
- (5) Potential equalisation stud



2.3 Keypad

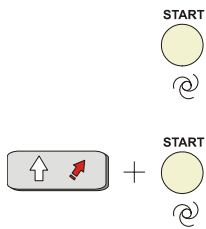
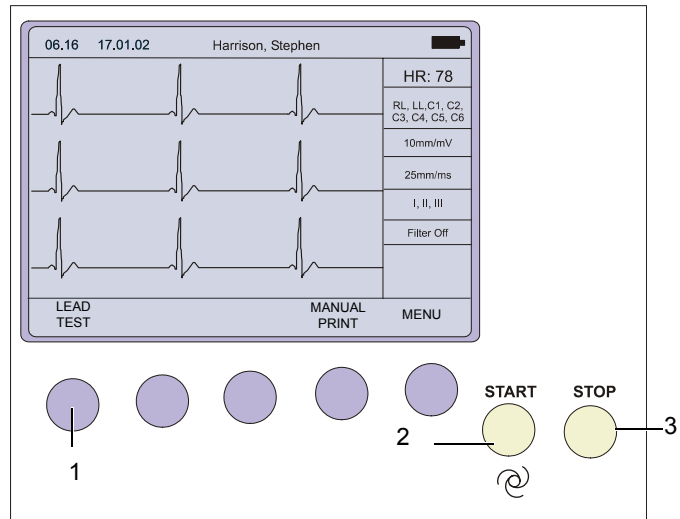

- (1) Softkeys - the function of these keys changes depending on the screen displayed. The function of these keys is shown on the screen above the keys. If nothing is written above a softkey, it has no function for the current screen.
- (2) Auto Mode recording (in Auto mode 1). Press the SHIFT followed by the START key (2) for auto mode 2.
- (3) STOP printout

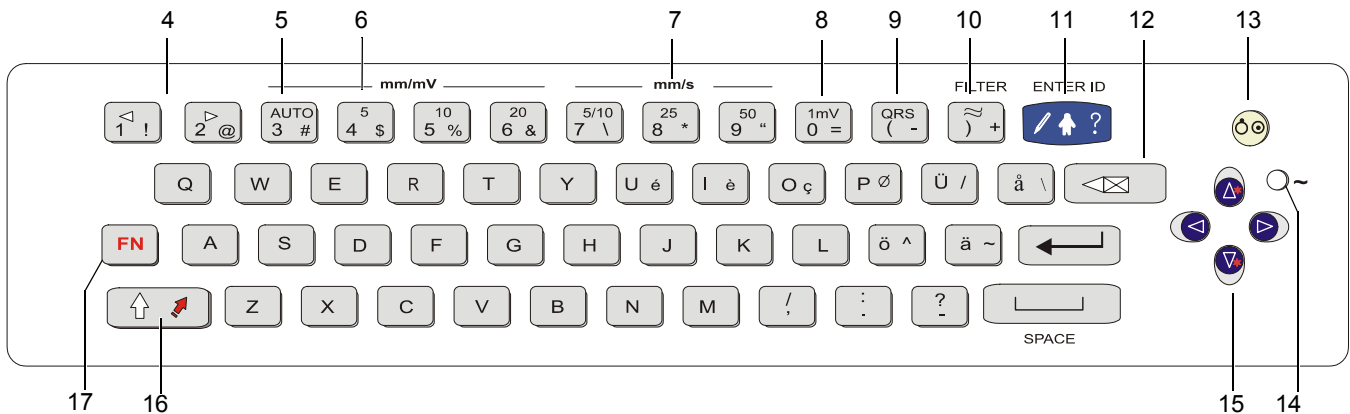

- (4) The top figures on the number keys '1' and '2' (designated < and >), change the lead group displayed on the screen, forward and backward resp.
- (5) Auto sensitivity key - automatically sets the ECG printout sensitivity (in AUTO mode only) to the best setting for the signal strength (5mm/mV or 10mm/mV)
- (6) The top figures on the number keys designated 5, 10, and 20 set the sensitivity of the ECG both on the screen and on the (manual) printout. The sensitivity is 5, 10 or 20 mm / mV.
- (7) The top figures on the number keys designated 5/10, 25, and 50 set the speed of the ECG both on the screen and on the (manual) printout. The speed on the screen can only be set to 25 or 50 mm/s. The speed of the manual printout can be 5, 10, 25 or 50 mm/s. The 5 and 10 mm/s settings are both on the same key which toggles the two speeds.
- (8) Inserts a 1mV reference marker on the screen and printout. Recentres the trace.
- (9) Toggles the QRS beeper ON/ OFF
- (10) Myogram filter ON / OFF. The cutoff frequency can be user defined in 'Setup'.
- (11) Patient data key. Press this key to enter a new patient or modify the data for the current one.
- (12) Delete last typed character.

i

The patient data screen, or the ECG screen is the first screen displayed on initial switch on. This is set for user preference in the SYSTEM SETTINGS/UNIT (see page 39).

- (13) ON / OFF Key
- (14) Mains Indicator - lit when mains connected.
- (15) Press the function key (16) and the UP/DOWN arrows to adjust screen contrast. When entering patient data use the LEFT/RIGHT arrow keys to move the cursor in the data field. Use the UP/DOWN arrow keys to go up/down to the next data entry
- (16) Shift key to select capital letters.
- (17) Function Key. When pressed before another key, initiates the second function of that key.
For example, second letters on the keypad -, é, è, ç, Ø, ›, @ etc., are entered by holding the function key before pressing the letter key.

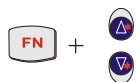

2.4 LCD Screen

The display will vary according to the current task being carried out. In all screens however, the top and bottom lines always display the same information: the top line displays system information, and the bottom line always gives the softkey options.

The following is an example of a typical resting ECG screen.

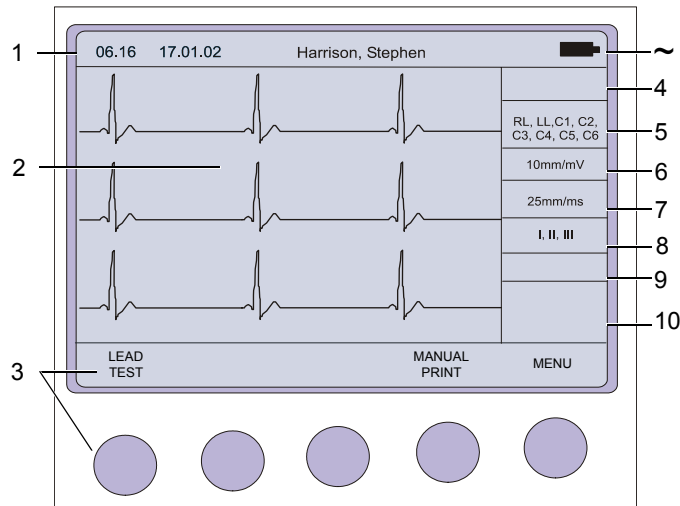

Items 1, 2 and 3 are in the same position for all screens.

- (1) Top line - time, date, patient name, and current power source - mains (~), or battery (■). When battery capacity is limited the battery symbol flashes.
- (2) Data acquisition area or data entry area.
- (3) Softkey designation. Pressing the key below the text carries out the function indicated. The options available will change according to the screen displayed.

Items 4 to 10 are specific for ECG acquisition only:

- (4) Current Heart Rate (averaged over 4 beats and refreshed every 2 seconds). The HR is also given on a manual printout. Note that with an auto mode printout the HR is averaged over the full 10 seconds of the recording.
- (5) Electrode connections - when an electrode indication flashes (an audible alarm is also given), it indicates that the electrode resistance is too high. The electrode(s) must be reapplied.
- (6) Sensitivity 5, 10 or 20 mm/mV. Change the sensitivity with the keys 3 (auto), 4, 5 and 6. An 'A' in this box indicates that automatic sensitivity is selected (auto mode printout only).
- (7) Speed 25 or 50 mm/s. Change the speed with the keys 8 and 9.
- (8) Lead indication (leads currently displayed on the screen). Change the lead group with the < and > keys on the keypad.
- (9) ¹Myogram Filter indication - 'Filter ON' or 'Filter OFF'. The filter is applied with the filter key.
- (10) Area for system messages or instructions.

1. The frequency of the filter cutoff is defined on page 35 menu Filters.

3 Operation

3.1 Start-up and Initial Preparation



▲ Danger of electrical shock. Do not operate the unit if the earth connection is suspect or if the mains lead is damaged or suspected of being damaged.

3.1.1 Connecting P8000

- (1) Potential equalisation
- (2) Mains connection (115 or 230 V)
- (3) RS-232 (see safety note paragraph 1.6)
- (4) Printer (see safety note paragraph 1.6)

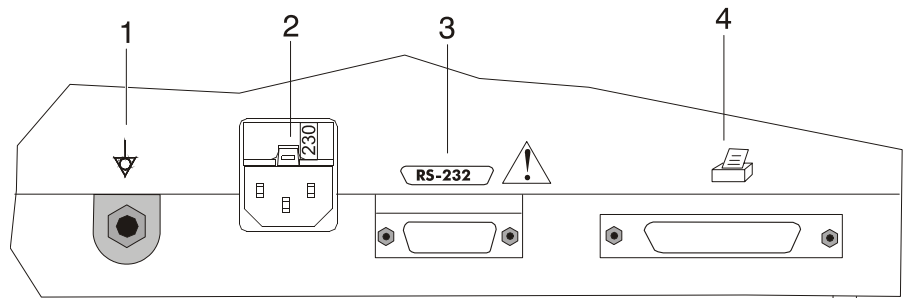
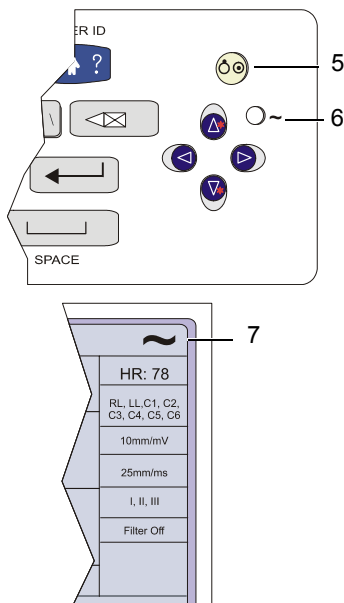

Fig. 3.1 P8000 back panel



1. Check Voltage setting (2) 115 or 230 V. Refer to chapter 6.4 for the mains voltage.
2. Connect the power cable at the rear of the unit. The mains indicator lamp (6) is always lit when the unit is connected to the mains supply. If the unit is switched on, the relevant symbol is displayed on the LCD (7). Leave the P8000 connected to the mains for 7 hours to fully charge the battery.
3. Connect the potential equalisation cable and all other necessary cables at the rear of the P8000.
4. Press the **on/off** button (5). The patient data or the ECG acquisition screen is displayed (see paragraph 5.3.1).
5. Check the settings according to chapters 5.
6. Connect the patient cable on the right side panel.

3.1.2 Battery Operation



Important

The unit can either be operated from the mains supply or from the built-in rechargeable battery. The power source is indicated on the top line of the LCD. The internal battery provides power for up to 3 hours.

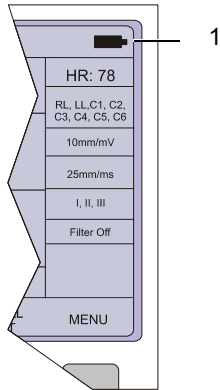

- When the unit is running on battery power a battery symbol (1) is displayed.
- When working from battery power, the unit is automatically switched off after 5 minutes (30 seconds if battery capacity is limited) if no key is pressed.
- for Battery recharging refer to chapter 6.3.
- The unit can remain connected to the mains supply without damage to either the battery or the unit.

3.1.3 Switching ON and OFF



→ The P8000 is switched ON and OFF with the ON/OFF key.

3.1.4 Isolating the Mains Supply

To isolate the power supply, remove the mains plug from the wall socket. (see Fig. 3.1)

3.1.5 Potential Equalisation



The potential equalisation stud (see Fig. Fig. 3.1) at the rear of the unit can be used to equalise the ground potential of the P8000 to that of all mains powered equipment in the vicinity. Use the hospital or building common ground



- ▲ To prevent the possibility of leakage current when an external printer is connected, always ensure that the mains lead, or the potential equalisation is attached to the P8000

3.1.6 Inserting Printing Paper



Important

The device is delivered without printing paper installed. Only use original ESAOTE printing paper. The thermo-paper is sensitive to heat, humidity and chemical vapours. Store the paper in a cool and dry area.

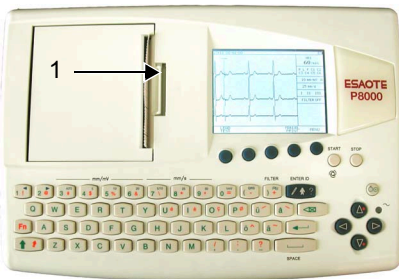

1. Press the locking catch (1) to the right.
2. Open the printer door upward.

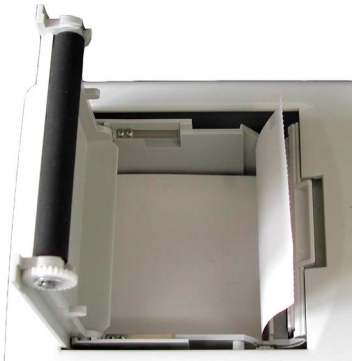

3. Insert paper and pull it down.
4. Close the cover. Be sure that the paper lies exactly between the rails.
5. Press the STOP key to transport the paper to the start position.

STOP



3.1.7 LCD contrast adjustment

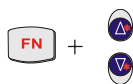

→ Press the function key FN and the UP/DOWN arrows to adjust screen contrast.

3.2 Entering Patient Data



In this screen a new patient can be entered, or the details of a selected patient can be modified.

→ Press the patient data key.

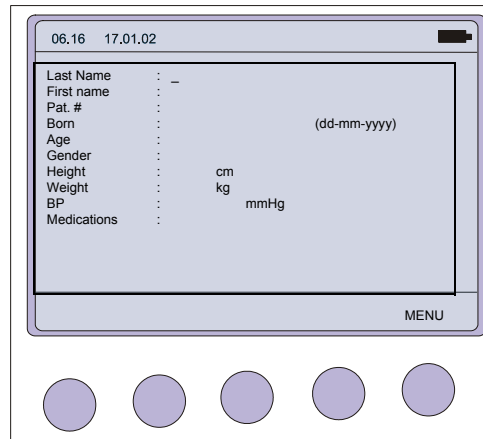

Last Name	Enter patients name (maximum 20 characters)
First Name	Enter patients first name (maximum 20 characters)
Pat. No.	The patient number is an easily identifiable short form of identifying a patient - a maximum of 20 characters can be entered.
Born	Enter patient's date of birth dd-mm-yyyy The patient age is calculated to the nearest year.
Age	Self calculated when entering date of birth.
Gender	Enter the patient's sex M or F
Height	Enter patient's height 20...250 cm (10...80 inches)
Weight	Enter patient's weight 0.5...250 kg (5...500 lbs)
BP	Enter the patient's systolic (or diastolic) blood pressure.
Medication	Up to 23 characters can entered for medication notes When all entries are made, press the softkey MENU to confirm the entered data.

4 Resting ECG

4.1 Electrode Placement



The colours shown here are according to Code 1 (European) requirements. The equivalent code 2 colours are given on paragraph 4.2.3.

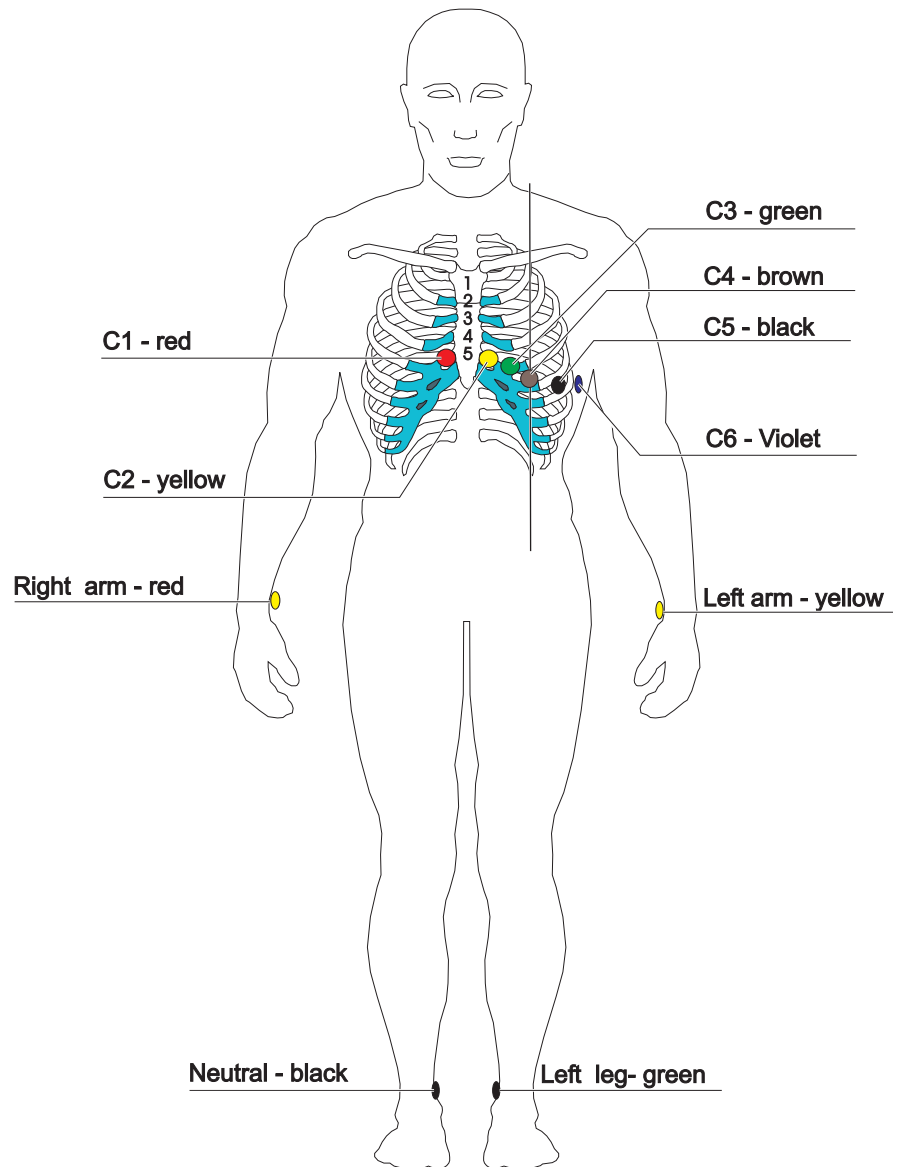

A minimal resistance between skin and electrode is required to obtain the best ECG signal and ensure the highest quality ECG recording. Therefore please note the following points:

1. Ensure that the patient is warm and relaxed.
2. Shave electrode area before cleaning.
3. Thoroughly clean the area with alcohol.
4. When applying the electrodes, ensure that a layer of gel is between the electrode and the skin.
5. Place the C4 electrode first - in the 5th intercostal space (ICS) so that it lines up approximately with the middle of the clavicle.
6. Then place:
 - C1 in the 4th ICS parasternal right
 - C2 in the 4th ICS parasternal left
 - C3 between, and equidistant to, C4 and C2
 - C6 on the patient's side and aligned with C4
 - C5 between, and equidistant to, C4 and C6

The electrode resistance can be checked in the recording screen - see paragraph [4.3.1](#).



When making an ECG with a child it is sometimes physically difficult to place all electrodes. When this is the case electrode C4 can be placed on the right side of the chest.



- ▲ During the ECG recording, ensure that neither the patient nor the leading parts of the patient connection nor the electrodes (including the neutral electrodes) come in contact with other persons or conductive objects, even when these are earthed.

4.2 Further Lead Combinations

4.2.1 Nehb Leads

The Nehb leads are bipolar chest leads. They are of special interest for the diagnosis of changes in the posterior ventricle wall. Three leads are arranged in the form of a triangle, also called the “small cardiac triangle”. Nehb dorsal (D) is measured between the electrode positions Nax and Nst; Nehb anterior (A) between Nap and Nst, and Nehb inferior (J) between Nap and Nax.

Place the electrodes as follows:

Colour Code	Electrode identifier	Applied to position
Red	C1 (Nst)	2nd rib at the right sternal border
Yellow	C2 (Nax)	directly opposite (on the back, posteriorly) from 3 (Nap)
Green	C3 (Nap)	5th intercostal space medioclavicular line (cardiac apex)

All other electrodes can be placed in their normal position. The user defined lead order must be set in the Setup menu:

MENU > SETUP > ECG SETTINGS > 4 x NEXT > NEHB (D, A, J) > on

See paragraph 5.2.5 for full details.

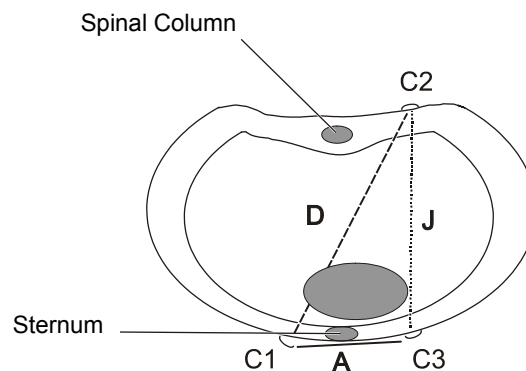

4.2.2 Electrode Positions for Additional Leads

The clips from the chest electrodes C1 through C3 have to be removed and connected to the electrodes C7 through C9 placed on the patients back in the appropriate positions. All other electrodes can be placed in their normal position.

The user defined lead order must be set in the Setup menu:
SETUP > ECG SETTINGS > 4 x NEXT > posterior and precordials options. Set on or off to display the additional leads.



→ During data acquisition, select the lead group with the lead group keys.

See paragraph 5.2.5 for full details.

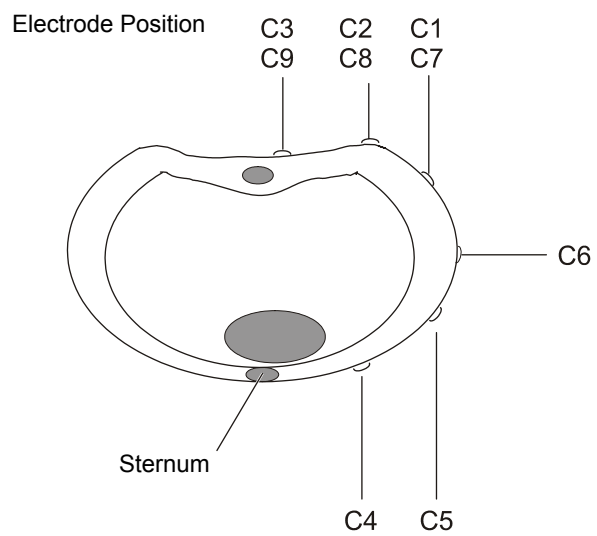

The additional leads C7 through C9 can only be recorded in manual mode.

4.2.3 Electrodes and Neutral Electrodes Identification and Colour Code

The electrode placements shown in this handbook are labelled with the colours according to Code 1 requirements. The equivalent Code 2 colours are given below.

System	CODE 1 (usually European)		CODE 2 (usually American)	
	Electrode identifier	Colour code	Electrode identifier	Colour code
Limb	R	Red	RA	white
	L	Yellow	LA	Green
	F	Green	LL	Red
Chest according to Wilson	C	white	V	Brown
	C1	White/red	V1	Brown/red
	C2	White/yellow	V2	Brown/yellow
	C3	White/green	V3	Brown/green
	C4	White/brown	V4	Brown/blue
	C5	White/black	V5	Brown/orange
Position according to Frank	C6	White/violet	V6	Brown/violet
	I	Light blue/red	I	Orange/red
	E	Light blue/yellow	E	Orange/yellow
	C	Light blue/green	C	Orange/green
	A	Light blue/brown	A	Orange/brown
	M	Light blue/black	M	Orange/black
	H	Light blue/violet	H	Orange/violet
F	Green	F	Green	
Neutral	N	Black	RL	Green

4.3 Skin/Electrode Resistance

4.3.1 High Electrode Resistance Indication

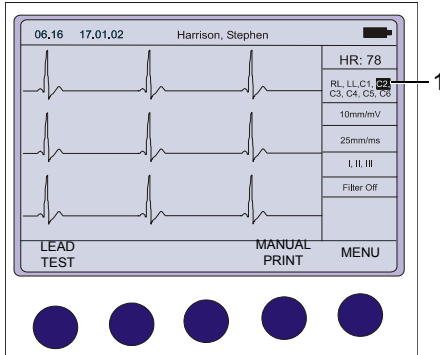

If an electrode resistance is too high for a good recording, or an electrode becomes dislodged during a recording, the electrode indication (1) flashes on the screen and an audible beep is heard. The electrode(s) must be reapplied.

Fig. 4.1 Data acquisition screen

4.3.2 Electrode and Patient cable Check (Lead Test)

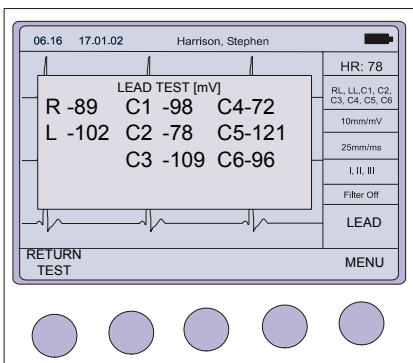

→ To check the electrode resistance and the integrity of the cable, press the LEAD TEST key from the data acquisition screen. (see Fig 4.1.)

This gives electrode dc offset and is the voltage drop in the patient cable. It can indicate any faults in the patient cable or patient electrode. The value given is the dc voltage between the left leg electrode and all other electrodes. The measurements obtained will indicate any cable short circuits or open circuits. The measured voltage value will depend on where the electrodes are connected. The voltage readings that can be expected are as follows:

- With patient connected (good connection, low resistance): $\pm 100\text{mV}$
An offset of up to $\pm 300\text{mV}$ will give an acceptable recording.
- With patient simulator connected: $\pm 20\text{ mV}$
This will depend on the patient simulator used and must be taken as a flexible measurement.
- With all electrodes shorted together: $\pm 20\text{ mV}$
- No patient cable connected: $-350\text{ to }-500\text{mV}$

4.4 Modes of Operation and Procedural Overview

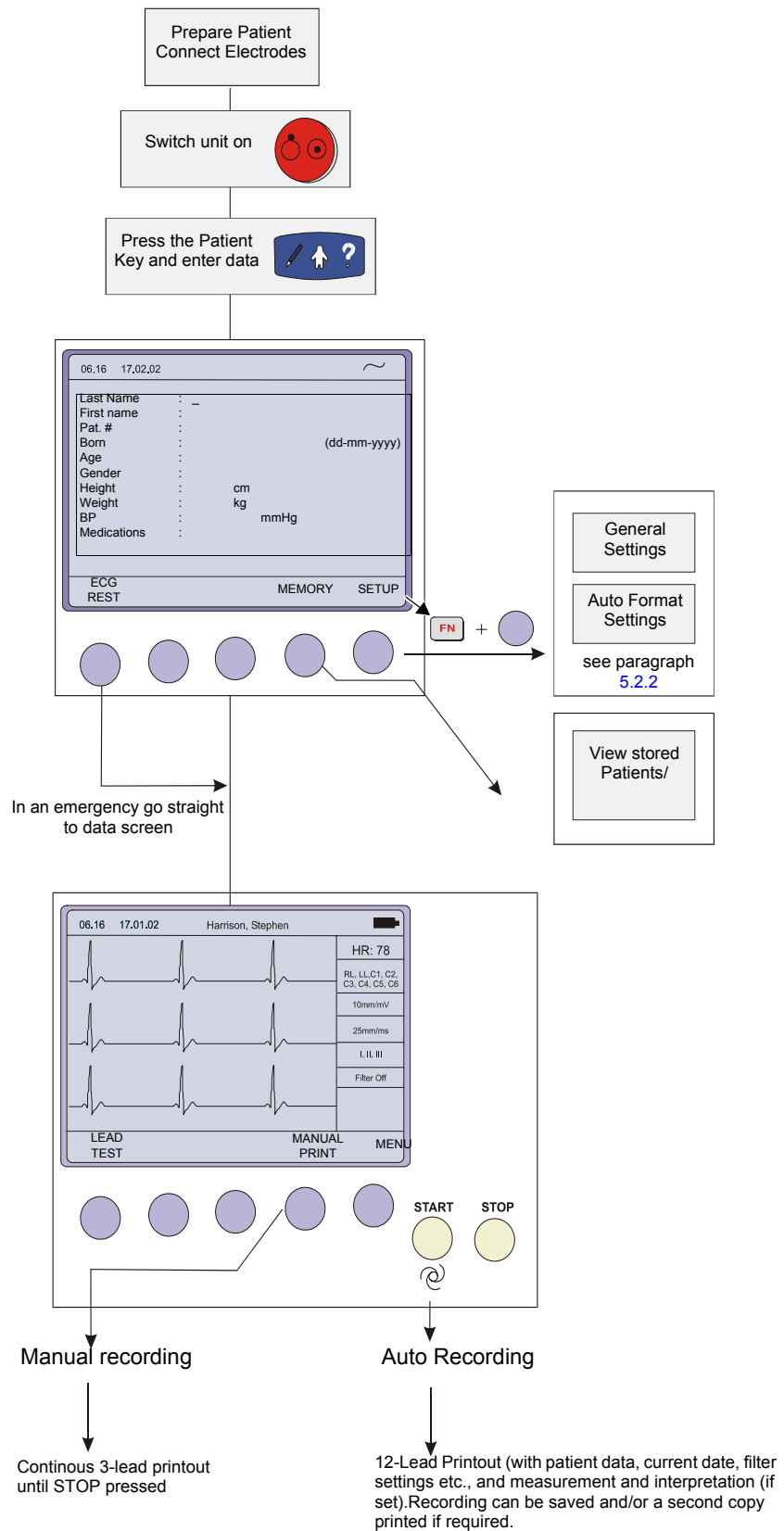

4.4.1 Automatic Mode

Two, user defined automatic mode formats are available. The following can be programmed freely for each of the 2 formats before recording:

- Lead Format
- Chart Speed
- With the optional interpretation program it is also possible to select the rhythm lead(s), measurement table, average cycles with optional markings and interpretation statements for the printout.

For further information and to define the auto formats see paragraph 5.2 ECG Settings.

→ To start an automatic ECG recording in Auto Mode Format 1, press the START key.

→ To start the automatic ECG recording in Auto Mode Format 2, press the SHIFT key followed by the START key.

After approximately 10 seconds the recording is analysed and the printout gives the following:

- ECG recording of all leads in either Standard or Cabrera format according to selection
- Sensitivity
- Heart Rate
- Speed
- Filter Settings
- Time and Date
- Interpretation statements (option)
- Average Cycles
- intervals
- Axis
- Sokolow Index (ECG index for hypertrophy)
- Detailed Measurement Table

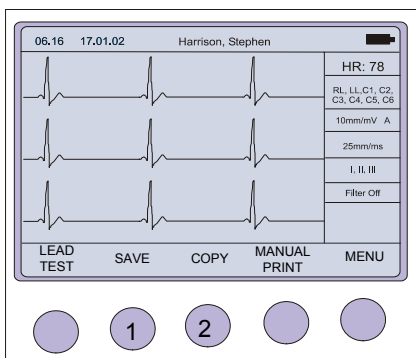
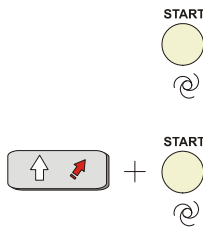

The softkey options change at the end of the recording to enable you to save (1) the recording or to obtain an extra copy (2). When a recording has been saved, it remains stored by the P8000 until deleted, even when the unit is switched off. Accessing recordings in the memory is detailed on paragraph 4.5.



When an external printer is connected, the printout is automatically directed to the external printer. When the external printer is unconnected or switched off, the P8000 automatically switches to the internal thermal printer.

4.4.2 Manual Mode

Manual mode provides a direct printout of the real-time ECG with full control of parameter selection.

- To start the manual recording of a real-time ECG, press the MANUAL printout softkey (1).
- To stop the manual recording (printout), press the STOP key (2), or the stop softkey.

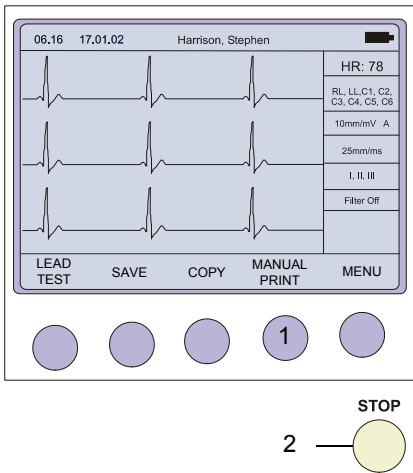

The printout provides you with the following:

- Three (selected) leads with lead identification.
- On the lower edge, the chart speed, user identification and the mains filter setting (50 or 60 Hz) and the Myogram filter cutoff frequency (if filter applied) 25Hz or 35Hz.
- At the top, the heart rate as current average of 4 beats, trace sensitivity, and the time and date

The lead group, the sensitivity, and the speed of the printout are changed using the display/printout keys (see next page).



- ▲ After heavy artefacts or lead off, the indication of the heart rate may not be reliable.



Manual real-time printout is not available on an external printer because data formatting protocol for inkjet (and laser) printers is too slow for real time processing. When a continuous real-time printout of the ECG is required, it is always printed on the internal thermal printer.

4.4.3 Screen (and Manual Printout) Settings

The following can be freely chosen during data acquisition, for both the display and for a manual printout, using the top line of keys of the keypad:

Lead Group

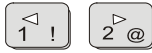

by means of the LEAD FORWARD and LEAD BACKWARD key. The following lead groups are selectable:

Standard and Cabrera Lead Group 1-4

Lead groupType	Lead group 1	Lead group 2	Lead group 3	Lead group 4
Standard	I, II, III	aVR, aVL, aVF	V1, V2, V3	V4, V5, V6
Cabrera	aVL, I, -aVR	II, aVF, III	V1, V2, V3	V4, V5, V6

Additional Lead Group 5-6

Two additionally lead groups can be viewed when manually set (on) in SETUP > ECG SETTINGS > LEADS (see page 37 for details).

Lead group type	Lead group 5	Lead group 6
Rhythm	II, avF, III	V2, V4, V5
Left Posterior	V4, V5, V6	V7, V8, V9
Right Precordial up to V5r	V1, V2, V3	V3r, V4r, V5r
Right Precordial up to V 6r	V1, V2, V3r	V4r, V5r, V6r
Nehb	D, A, J	

Sensitivity

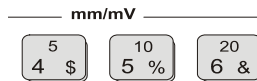

Sensitivity Select 5, 10 or 20 mm/mV

Auto Sensitivity



To reduce the possibility of overlapping traces, an auto sensitivity reduction is applied in Auto Mode (default). This means that the unit detects very large waveform amplitudes and sets the sensitivity for the extremity and/or precordial leads to 5 mm/mV. An 'A' by the side of the sensitivity indicates that Auto sensitivity is set. To disable this function, the AUTO SENSITIVITY key (key 3) must be pressed.

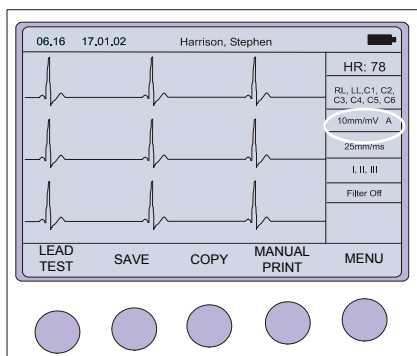
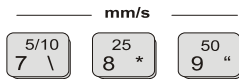

Chart Speed



Select speed 5, 10, 25 or 50mm/s

Key 7 is a toggle key - press once and 5 is selected, press a second time and 10mm/s is selected.

When the 25 or 50mm/s key is pressed, the same speed is set on both the screen and the (manual) printout. When 5 or 10 mm/s is selected, this affects the manual printout speed only.

Myogram Filter



Switch the filter ON or OFF with the FILTER key:

'FILTER ON' is displayed on the LCD when the filter is switched on and the cutoff frequency is shown at the bottom of the printout. That is 0.05 - 25 Hz, or 0.05 - 35 Hz. The cutoff frequency is defined on page 35.

Recentring



Press the 1mV key to re-centre the ECG traces and/or displaying a 1mV pulse on screen and printout.

QRS Beep



To activate / Deactivate the QRS beep, press the QRS key

4.5 Memory (option)

The memory option allows approximately 40 recordings (depending on size and parameters specified when the recording was taken) to be stored, edited, printed, and transmitted over the RS-232 interface. When no more recordings can be stored, the message 'Memory Full' is displayed. Old recordings must be deleted before further recordings can be stored

Recordings can be automatically saved after a recording has been made (auto save), or you are prompted to save a recording individually after a recording has been made. This setting is defined in the ECG settings (see page 37).

1. Enter the memory from the initial screen.
All recordings are stored in date order.

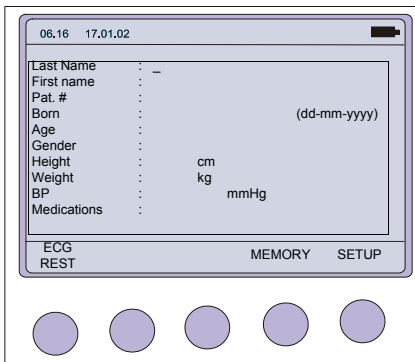

2. Highlight required recording by pressing the up/down softkeys.
To highlight all recordings press the function key **FN** + **A**.
3. When the required recording is highlighted, press the ENTER softkey.
4. Press the ENTER softkey to show the following softkeys:

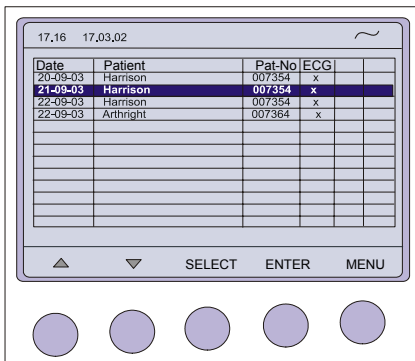

Softkey options then enables you to obtain a:

- printout (PRINT)
- deletes the selected recording (DELETE)
- sends the content of the memory over the RS-232 interface to Archimed data management Software. (TRANSMIT)

When Delete is selected, the message 'ERASING' appears in the message box, during the erasing process.

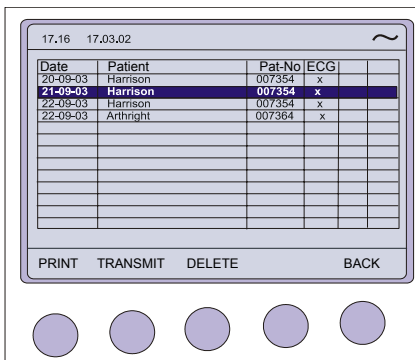

The print settings are defined in Setup and are described in paragraph 4.4.3 and 5.2.2.

4.5.1 Transmitting the Recordings



- ▲ When non-medical devices are connected to the RS-232 interface ensure that both units are securely connected to the same earth potential.
- ▲ When operating the unit on battery and simultaneously using non-medical devices, the RS-232 interface must be fully isolated.
- ▲ An external device must only be connected using the original interface cable assembly.

The contents of the memory can be transmitted to the ArchiMed data management program, using the RS-232 connected directly to the computer, or over the telephone system. Sending directly is termed LINE transmission; sending over the telephone system requires a modem and this form of sending is termed MODEM.

When Transmit is selected, the message 'TRANSMITTING' appears in the message box, during the transmission.

Line Transmission

To transmit recordings over line, proceed as follows:

1. Set Communication mode to LINE - see page 40
2. Connect the cable assembly (optional accessory, art. No. 8830649000) between the RS-232 connector on the P8000 plus and the COM interface of the Computer.
3. Ensure that the ArchiMed SW communication program is active on the computer (see ArchiMed SW handbook).
4. Press the TRANSMIT softkey.

Modem Transmission

To transmit recordings over the telephone network, proceed as follows:

1. Set Communication mode to MODEM - see page 40
2. Enter Phone number and modem initialisation codes - see page 40
3. Connect the modem cable assembly (supplied with modem) between the RS-232 connector on the P8000 and the modem.
4. Ensure that the ArchiMed SW communication program is active on the remote computer (see ArchiMed SW handbook).
5. Press the TRANSMIT softkey

The message TRANSMITTING appears while the unit is sending

If a transmission error occurs the message Tx ERROR is displayed.

- Check all settings in the ArchiMed SW communication program
 - baud rate
 - parity - none
 - stop bit - 2
 - time between blocks, records - 100ms
- Check that the transmission speed is the same in both the P8000 and the Archi-Med SW communication program.



The transmission settings are defined in Setup and are described in paragraph 5.3.2.

5 Setup

5.1 Entering the SETUP Menu

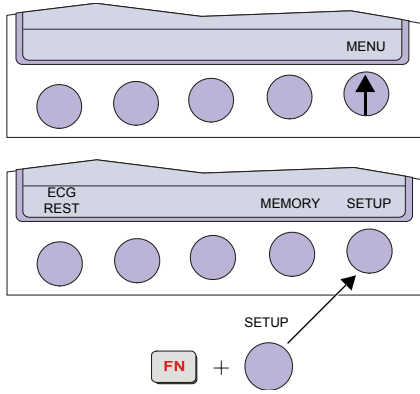

To enter the setup screen press the following keys.

1. Press the softkey MENU.
2. Press the function key FN and the softkey SETUP.
Note:
The Setup text above the key appears first if the FN key is pressed.

5.1.1 Navigating in the Setup Screens

In setup screens where there are two choices, navigation to the next screen and selection of specific settings. This is as follows

Navigation with Softkeys

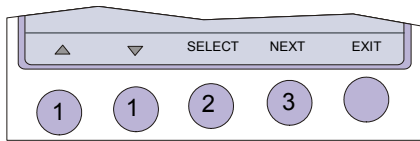

1. Select desired parameters with the softkeys UP/DOWN (1).
2. Change setting with the softkey SELECT (2) and UP/DOWN (1).
3. Confirm the setting with the softkey SELECT (2).
4. Go to the next screen with the softkey NEXT (3)

Navigation with keypad buttons

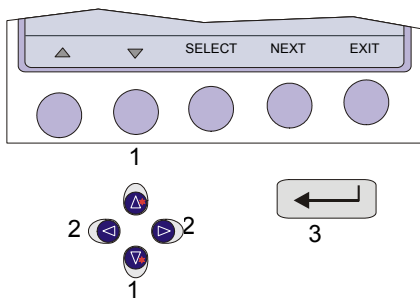

1. Select desired parameters with the arrows keys UP/DOWN (1).
2. Change setting with the ENTER key (3) and the arrows keys UP/DOWN (1).
3. Confirm the setting with the ENTER key (3).
4. Go to the next/previous screen with the arrows keys LEFT/RIGHT (2).

5.2 ECG Settings

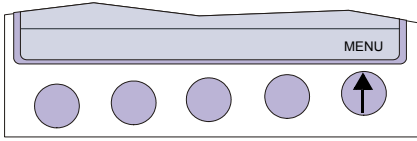

1. Press the softkey MENU.

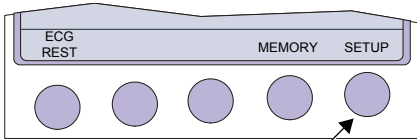

2. Press the function key FN and the softkey SETUP.

Note:

The Setup text above the key appears first if the FN key is pressed.

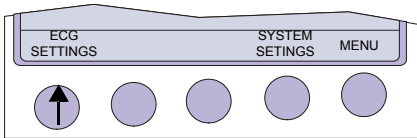
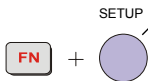

3. Press the softkey ECG SETTINGS.

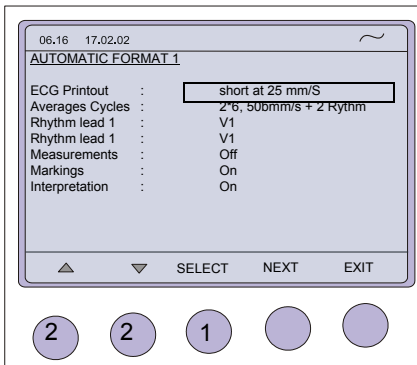

The following pages detail the programmable ECG parameters:

- Use the SELECT softkey (1) to select the different settings.
- Use the UP/DOWN softkeys (2) to highlight the various options.

→ Use the NEXT softkey to go to the next menus

- Automatic Format 1 and 2 internal
- Automatic Format 1 and 2 external
- Filter
- Interpretation
- Lead
- General

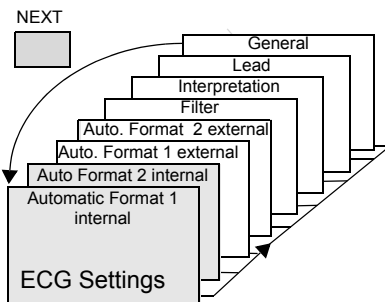

In units where the interpretation option is not installed, interpretation statements, cannot be displayed.

5.2.1 Automatic Format 1 and 2 Internal Printer

Two separate Auto formats can be defined for the internal printer.

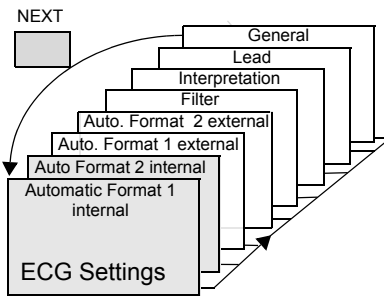

Press the SELECT softkey to choose from the following options:

Parameter	Options	Description
ECG Printout	No Printout	No printout of the ECG given at the end of an auto mode recording (the recording can be stored in the memory and printed at a later time if required).
	Short at 25 mm/s	Leads are printed in short form (1 sheet) at 25 mm/s.
	Short at 50 mm/s	Leads are printed in short form (1 sheet) at 50 mm/s.
	Long at 25 mm/s	Leads are printed in long form (2 sheets) at 25 mm/s.
	Long at 50 mm/s	Leads are printed in long form (2 sheets) at 50 mm/s.
Average Cycles	No Printout	No printout of the ECG given at the end of an auto mode recording (the recording can be stored in the memory and printed at a later time if required).
	4*3, 25 mm/s	Leads are printed in a 4 * 3 format at 25 mm/s
	4*3, 50 mm/s	Leads are printed in a 4 * 3 format at 50 mm/s
	2*6, 50 mm/s + 1 Rhythm	Leads are averaged over the entire 10 second recording and printed in 2 groups of 6 at 50 mm/s, with the one rhythm lead at the bottom of the page.
	1*12, 50 mm/s + 2 Rhythm	Leads are printed in a 1 * 12 format at 25 mm/s - with 2 rhythm leads printed.
Rhythm Lead 1	I, II, III, aVR, aVI, aVF, V1 to V6	Select any lead.
Rhythm Lead 2	I, II, III, aVR, aVI, aVF, V1 to V6	Select any lead.
Measurements	On/Off	Select on or off to print a detailed table of measurement results.
Markings	On/Off	Select on or off to print reference markings on the ECG average cycle print. A vertical marker shows the beginning and end of P wave and QRS, and the end of the T wave
Interpretation	On /Off	Select on or off to print interpretation statement



The sensitivity of the interpretation and the printing/not printing of abnormality statements can additionally be set for the interpretation. These are described in paragraph 5.2.4.

5.2.2 Automatic Format 1 and 2 External Printer

Two separate Auto formats can be defined for a external printer.

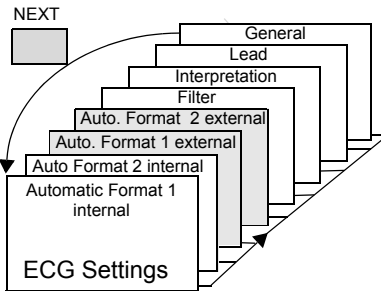

Press the SELECT softkey to choose from the following options:

Parameter	Options	Description
ECG Printout	No Printout	No printout of the ECG given at the end of an auto mode recording (the recording can be stored in the memory and printed at a later time if required).
	4*3 + 1 Rhythm	Leads are printed in a 4 * 3 format at 25 mm/s, with the selected rhythm lead at the bottom of the page at 25 mm/s.
	1*12 at 25 mm/s	Leads are printed in a 1 * 12 format at 25 mm/s - no rhythm lead printed.
	8*5 s + 4*10 s	The first 8 leads printed for 5 seconds and the last 4 leads printed for 10 seconds.
	Short at 25 mm/s	Leads are printed in short form (1 sheet) at 25 mm/s.
	Short at 50 mm/s	Leads are printed in short form (1 sheet) at 50 mm/s.
	Long at 25 mm/s	Leads are printed in long form (2 sheets) at 25 mm/s.
	Long at 50 mm/s	Leads are printed in long form (2 sheets) at 50 mm/s.
Average Cycles	No Printout	No printout of average cycles
	4*3, 25 mm/s + 2 Rhythm	Leads are averaged over the entire 10 second recording and printed in 4 groups of 3 leads at 25 mm/s, with the two selected rhythm leads at the bottom of the page at 25 mm/s.
	4*3, 50 mm/s + 2 Rhythm	Leads are averaged over the entire 10 second recording and printed in 4 groups of 3 at 50 mm/s, with the two selected rhythm leads at the bottom of the page at 25 mm/s.
	2*6, 50 mm/s + 2 Rhythm	Leads are averaged over the entire 10 second recording and printed in 2 groups of 6 at 50 mm/s, with the two selected rhythm leads at the bottom of the page at 25 mm/s.
Rhythm Lead 1	I, II, III, aVR, aVI, aVF, V1 to V6	Select any lead.
Rhythm Lead 2	I, II, III, aVR, aVI, aVF, V1 to V6	Select any lead.
Measurements	On/Off	Select on or off to print a detailed table of measurement results
Markings	On/Off	Select on or off to print reference markings on the ECG average cycle print. A vertical marker shows the beginning and end of P wave and QRS, and the end of the T wave
Interpretation	On /Off	Select on or off to print interpretation statement



The sensitivity of the interpretation and the printing/not printing of abnormality statements can additionally be set for the interpretation. These are described in paragraph 5.2.4.

Full details of the interpretation option are given in the ESAOTE ECG Measurement and Interpretation booklet (art. No. 9740440088).

5.2.3 Filters

There are five different filters which can be set individually as follows.

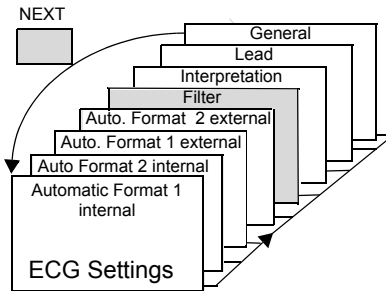

Parameter	Options	Description
Baseline filter	0.05, 0.15 or 0.3 Hz	The set value is the lower limit of the frequency range and is normally set to 0.05 Hz. The settings 0.15 and 0.30 Hz should only be used when absolutely necessary, as the possibility exists that they could affect the original ECG signal, especially the ST segments.
Myogram filter	25 or 35 Hz	<p>The Myogram filter suppresses disturbances caused by strong muscle tremor. The filter is applied by pressing the FILTER key (or programmed on as default when the unit is switched on).</p> <p>When the Myogram filter is on, 'FILTER ON' is displayed in the information box.</p> <p>The cutoff frequency is user defined at 25Hz or 35Hz. When 'off at power up' is selected, the Myogram filter is off when the unit is first switched on.</p> <p>Note An ECG recorded in auto mode is stored unfiltered. It is therefore possible to print the stored ECG either with or without passing the myogram filter. Filter ON is indicated on the LCD.</p>
Myogram filter	On at power up Off at power up	Selection if filter is standard switched on or off during power up.
Mains filter	Off 50 Hz 60 Hz	<p>The mains filter is an adaptive digital interference filter designed to suppress ac interference without attenuating or distorting the ECG.</p> <p>Set the mains filter in accordance with the frequency of your local mains supply.</p>
Baseline Stabiliser (P8000 SBS)	Off/On	The baseline stabiliser greatly reduces the baseline fluctuations without affecting the ECG signal. The purpose of the stabiliser is to keep the ECG signals on the baseline of the printout. This filter is only effective in auto mode printout. The Baseline Stabiliser is applied to a recording (on), or not applied to a recording (off).
Smoothing Filter P8000 SSF)	Off/On	The smoothing filter is a low pass filter to suppress high frequency artefacts between the QRS complexes. When this filter is switched on, 'SSF' is shown on the bottom line of the automatic printout.

5.2.4 Interpretation (Only with version C)

The interpretation settings enable the user to determine whether or not certain comments will be added to the interpretation statements on the ECG printout. Furthermore, the patient's age can be assumed (<30 or >30). Low or high can also be set for interpretation sensitivity. Low sensitivity will suppress certain non-specific ECG diagnoses; this may be advisable when carrying out ECGs for screening.

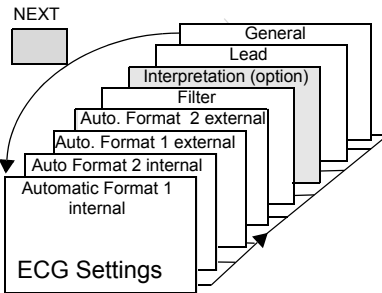

Parameter	Options	Description
Sensitivity	High or low	Selecting sensitivity
Age Assumed to be	<= 30 yrs > 30 yrs	Greater than 30 years, or 30 years and under Note The 'Patient age assumed to be..' setting is only applicable when patient data has not been entered. When a patient's date of birth has been entered, this setting is ignored.
Abnormal ECG	Print/Not Print	Normal' / 'Abnormal' is printed or not printed
Unconfirmed Report	Print/Not Print	Unconfirmed Report' is printed or not printed
Thrombolysis	On/Off	(Only with C Software option)

5.2.5 Leads

Defining Lead Sequence & Printout

The required settings can be selected as follows:

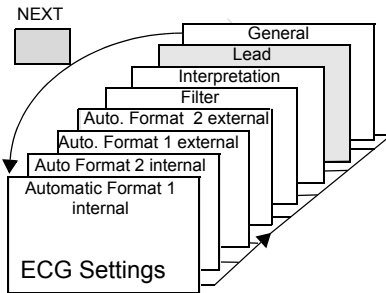

Parameter	Options	Description
Lead Sequence	Standard or Cabrera	Select between Standard lead sequence or Cabrera. Lead groupings are shown on page 27.
Signals	Simultaneous	All ECG leads are printed in the same time segment (in automatic mode only)
	Sequential	Each group is a contiguous time segment of approximately 2.5 or 5 seconds (in automatic mode only).
Auto-Centering	On	All ECG traces are centred dynamically for optimal use of paper width.
	Off	Off ECG traces are set to a fixed baseline position and may possibly overlap
The lead group settings allow two extra leads to be displayed on the screen when set to 'On'. The following lead groups can be displayed:		
^a Rhythm Lead Group	On/Off	Lead group 5: II, avF, III Lead group 6: V2, V4, V5
^a Left Posterior (V4-V9)	On/Off	Lead group 5: V4, V5, V6 Lead group 6: V7, V8, V9
^a Right Precordials (V5r)	On/Off	Lead group 5: V1, V2, V3 Lead group 6: V3r, V4r, V5r
^a Right Precordials (V6r)	On/Off	Lead group 5: V1, V2, V3r Lead group 6: V4r, V5r, V6r
^a Nehb (D, A, J)	On/Off	Lead group 5: D, A, J, (only three leads)

a. The above leads can also be printed when displayed (only in manual mode). The lead groups are changed both on the screen and on the manual printout with the lead next/previous keys.

5.2.6 General (only with version m = Memory)

Parameter	Options	Description
Auto-Storage	Off/Manual/ Automatic	When "Automatic", recordings are automatically saved when an ECG is completed. When manual is selected, the user is prompted to save an ECG recording when completed.

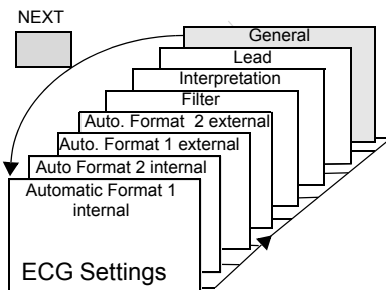

5.3 System Settings

The SYSTEM SETTINGS are entered by selecting MENU SETUP and SYSTEM SETTINGS from the initial screen:

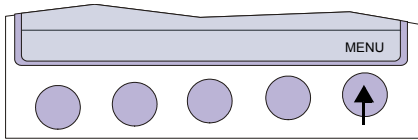

1. Press the softkey MENU

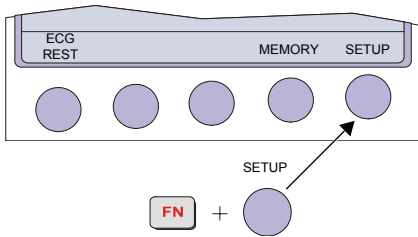

2. Press the function key FN and the softkey SETUP.

Note:

The Setup text above the key appears first if the FN key is pressed.

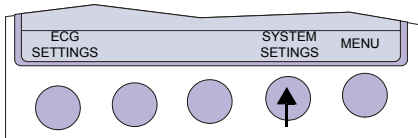

3. Press the softkey SYSTEM SETTINGS.

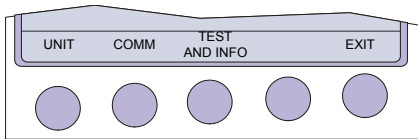

4. Press the softkey UNIT.

The following pages detail system settings for the P8000:

- Use the SELECT softkey (1) to select the different settings
- Use the UP/DOWN softkeys (2) to highlight the various options.

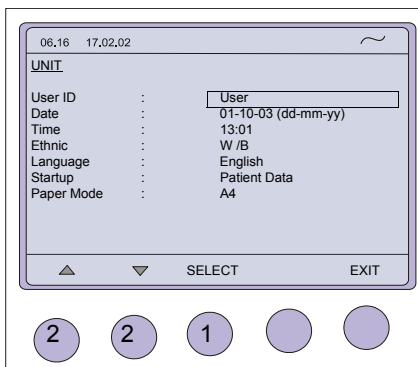

5.3.1 Unit

→ Press softkey UNIT

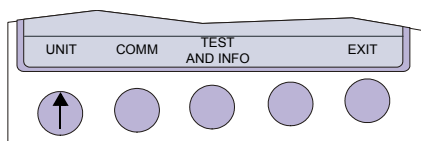

Parameter	Options	Description										
User Identification (User ID)	Enter user ID	The user identification is printed on all recordings. The user ID can be the department, doctor or hospital etc. Select User ID and a blinking cursor is present - enter up to 30 characters via the keypad. Note If the unit is reset to the default settings (see following), the user identification must be re-entered.										
Date	dd-mm-yy	Enter the date in the format day.month.year. When set, the ENTER key must be pressed to confirm.										
Time	hrhr/minmin	Enter the time using the standard 24 hr notation. When set, the ENTER key must be pressed to confirm.										
Language	Deutsch English (Default) Francais Svensk American Italiano Espanol Portuges Dutch	Several languages are already programmed into the unit. Select the language for the screen display and for the printout. The language will also set the units used by the system. The difference between American and English is as follows: <table border="0"> <tr> <td>American</td> <td>Standard English</td> </tr> <tr> <td>measurements in inches</td> <td>measurements in centimetres</td> </tr> <tr> <td>temperature in Fahrenheit</td> <td>temperature in degrees centigrade.</td> </tr> <tr> <td>Mains filter setting - 60Hz</td> <td>mains filter setting - 50Hz</td> </tr> <tr> <td>date order mm-dd-yy</td> <td>date order dd-mm-yy</td> </tr> </table>	American	Standard English	measurements in inches	measurements in centimetres	temperature in Fahrenheit	temperature in degrees centigrade.	Mains filter setting - 60Hz	mains filter setting - 50Hz	date order mm-dd-yy	date order dd-mm-yy
American	Standard English											
measurements in inches	measurements in centimetres											
temperature in Fahrenheit	temperature in degrees centigrade.											
Mains filter setting - 60Hz	mains filter setting - 50Hz											
date order mm-dd-yy	date order dd-mm-yy											
Start-up Screen	Patient Data Resting ECG	Here you can specify the first screen to be displayed when the unit is switched on. Select between patient data screen (for entry of new patient) or data acquisition screen (ECG).										
Paper	A4 Letter	The external printer can print on A4 or letter size paper. Set according to the paper used.										

5.3.2 Communication

→ Press softkey COMM

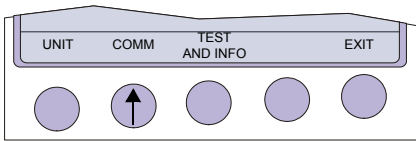

Parameter	Options	Description
Baudrate	9600	Select a Baud rate according to the modem/computer used. Most computers can connect at 115200 Baud and the standard modem speed is 57600 Baud. If problems are experienced during transmission reduce the Baud rate.
	14400	
	19200	
	28800	
	38400	
	57600	
	115200	
Mode	Line	<ul style="list-style-type: none"> line (computer connected directly to the RS-232 interface) modem (for transmission over the phone network)
	Modem	
Phone No.	T, 0417608787	Enter the telephone number preceded by 'T' or 'P' (tone or pulse). A comma ',' gives a one second pause in dialling - this may be necessary for example, if an outside line is required.
	P, 0417608787	
Modem Init.	ATB0L1V0Q0E0S0=0	Enter the modem initialisation codes. Full details will be found in the user guide for your modem. However, the modem initialisation must contain at the minimum, the following commands with the prefix 'AT'.
		<ul style="list-style-type: none"> 'Q0'- modem sends response 'V0'- numerical response codes 'VE0'- no command echo <p>The standard modem initialisation code is: ATB0L1V0Q0E0S0=0</p>

If in doubt about any of these settings, please contact your phone company and/or modem supplier.

5.3.3 Test and Information

→ Press softkey TEST AND INFO to display following screen:

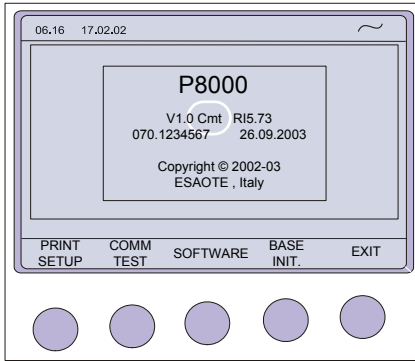
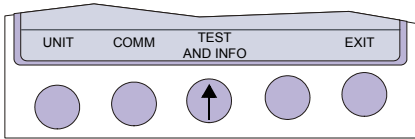

A code of the options installed is given after the software version. These are as follows:

Basic configuration

M = Measurement
C = Measurement and Interpretation

Optional configuration

m = Memory
t = Thrombolysis

5.3.3.1 Print Setup

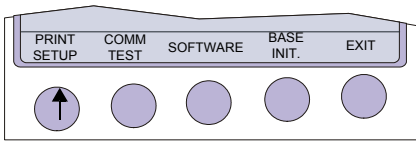

→ To obtain a printout press the PRINT SETUP softkey.

A printout of the defined settings will be produced and gives the following information, depending on the installed software:

Printout for Internal and external

Print Setup Menu	Parameter	Settings
ECG Format (1 and 2)	Speed	Default speed setting
	Internal & external	Auto printout
	MECG	Average cycles as defined in auto ECG recording setup (e.g. 4 * 3 (25 mm/s) + 2)
	Rhythm leads	Leads selected for R1, R2 resp.
	Measurements	Print - Enabled (+) or Suppressed (-)
	Marks	Print - Enabled (+) or Suppressed (-)
	Interpretation	Print - Enabled (+) or Suppressed (-)
Leads	Sequence	Standard (S) or Cabrera (C)
	Signals	Printout of signals - Sequential or Simultaneous
	Auto Centering	Enabled (+) or Suppressed (-)
	Lead Group	Rhythm, V9, V4r, V6r, DAJ, ON (+) or OFF (-) for each lead group
Filter	Baseline Filter	0.05, 0.15 or 0.30 Hz
	Mains Filter	50, 60 Hz or OFF (-)
	Myogram Filter	25 or 35 Hz, ON (+) or OFF (-)
	SSB Filter	Smoothing Filter Enabled (+) or Suppressed (-)
	SSF Filter	Baseline Stabiliser Enabled (+) or Suppressed (-)
Interpretation (only with option Interpretation)	Sensitivity	Low (-) or high (+) sensitivity
	A30	Patient age is assumed to be < 30 (-) or >30 (+)
	U	'Unconfirmed report' is written (+) or suppressed (-)
	Abnormal	Normal / Abnormal printed Enabled (+) or Suppressed (-)
	Thrombolysis	ON (+) or OFF (-)
Comm	Baud rate	115200, 57600, 38400, 28800, 14400 or 9600. This is followed by parity setting (Y/N), bits and number of stop bits.
	Mode	Line or Modem

5.3.3.2 Communications Test

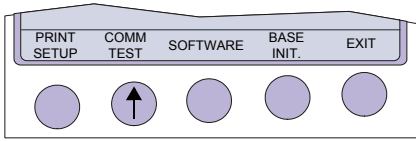

When this is selected, test options are given for the RS-232 communication port. Use this test if the RS-232 port is suspected of malfunction. A special test plug is used to carry out the UART test.

5.3.3.3 Installing New Software Options (Upgrade)

Use the upgrade option to install any available software options (e.g. Measurement). To install new options in the P8000, a code must be entered. This code must be obtained from ESAOTE. To install software option proceed as follows:

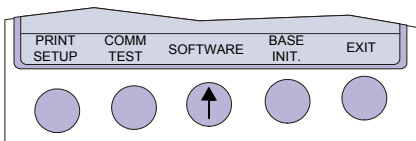

1. Enter the TEST and INFO screen
SETUP > SYSTEM SETTINGS > TEST AND INFO
2. Select SOFTWARE.

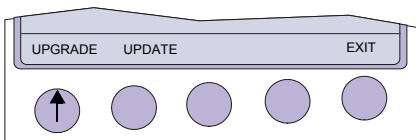

3. Select UPGRADE.
4. Enter the upgrade code.
When the correct code is entered, acceptance of the code is indicated by a series of beeps. The option can be used immediately.



▲ More than 10 attempts to enter the incorrect code blocks the unit

5.3.3.4 Update the Software

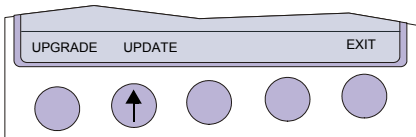

→ Use the Update option to update the current software.
Details to update the software is given in the P8000 Service Handbook.

5.3.3.5 Default Settings

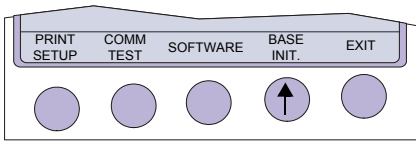

To reset the unit to the base default settings, press the BASE INIT softkey. As the unit resets to the default values a message is briefly displayed on the LCD. The base settings (Defaults) are given on the following page.

Unit Defaults Table

Settings	Standard	With Interpretation
Language	As set	As set
Auto Format 1	ECG: 25mm/s, short (o)	ECG: 25mm/s, short (o)
Internal	Rhythm Leads V1	Rhythm Leads V1, II
		MECG: 2*6 (50mm/s + 1)
		Measurements: Suppressed (-)
		Marks: Enabled (+)
		Interpretation: Enabled (+)
Auto Format 2 external	ECG: 25mm/s, Long (ooo)	ECG: 25mm/s, long (ooo)
	Rhythm Leads V1	Rhythm Leads V1, II
		MECG: none
		Measurements: Suppressed (-)
		Marks: Enabled (+)
		Interpretation: Enabled (+)
Filter	Baseline 0.05Hz	Baseline 0.05Hz
	Mains Filter 50Hz (60Hz)	Mains Filter 50Hz (60H)
	Myogram off at power up	Myogram off at power up
	Myogram 35Hz, OFF	Myogram 35Hz, OFF
	SBS OFF (-)	SBS OFF (-)
	SSF OFF (-)	SSF OFF (-)
Interpretation Settings		Sensitivity low (-)
		Age: <= 30 (-)
		Abnormal ECG Not Print
		Unconf. Report Print (+)
		Thrombolysis OFF (-)
Leads	Sequence Standard (S)	Sequence Standard (S)
	Signals Sequential	Signals Sequential
	Autom. Centering ON (+)	Autom. Centering ON (+)
	Rhythm On (+)	Rhythm On (+)
	V4-9 On (+)	V4-9 On (+)
	V5r Off (-)	V5r Off (-)
	V6r Off (-)	V6r Off (-)
	Nehb DAJ Off (-)	Nehb DAJ Off (-)
General	Storage mode manual	Storage mode manual
Memory and Communication	Baud rate 57600 bps	Baud rate 57600 bps
	Trans. mode: line	Trans. mode: line

6 Care & Maintenance



Maintenance work not described in this chapter, e.g. battery changes, may only be accomplished by a qualified technician.

Self-test

Every time the unit is switched on a built-in test program is initiated. If an error is detected, the unit will not switch on and a table may be displayed giving information for the service staff. Details of the test program is given in the P8000 Service Handbook.

6.1 Communication (RS-232) Test

A built-in program to check the transmission connector. This test is entered from the 'setup' menu:

SETUP > SYSTEM SETTINGS > TEST AND INFO > COMM TEST

This test uses a special test plug (not supplied) which shorts the incoming/outgoing connectors to check transmission line and connector to ensure that the P8000 transmission circuits are functioning. Details of this test are given in the P8000 Service Handbook.

6.2 12 Monthly Check

It is stipulated that a technical safety check must be performed at least every 24 months. It is strongly recommended however, that the unit undergoes a technical safety check every 12 months. This safety check shall include the following:

- Visual inspection of the unit and cables.
- Electrical safety tests according to EN 60601-1 (1990) Clause 19
- Functional tests according to the Service Handbook.

The test results must be documented.

6.3 Maintenance interval for the battery



Important

The battery is maintenance free during its normal life.

The battery should remain charged during storage. If the storage period exceeds three months, recharge the battery.

- during normal operation no maintenance necessary.
- If not used every 3 months.
- replace the battery approx. every 4 years (depending upon application) if the actual running time falls substantially under 1 hour.

6.3.1 Charging the battery



Important

A totally discharged battery requires approx. 7 hours to be 90% recharged.

It is possible to use the unit when the battery is being charged. However, when this is the case, the charging time of the battery will be substantially extended!

1. Connect the device to the mains but do not switch it on.
2. The LED for mains supply (1) is lit.
3. Charge the battery for at least 7 hours.

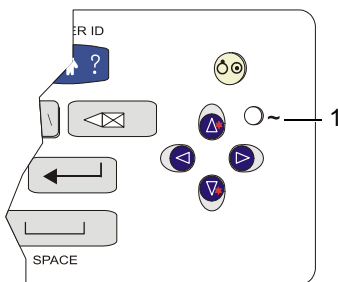

6.3.2 Battery disposal



- ▲ Danger of explosion! Battery may not be burned or disposed of domestic refuse.
- ▲ Danger of acid burns! Do not open the battery.



The battery is to be disposed of in municipally approved areas or sent back to ESAOTE.

6.4 Changing the fuse and mains voltage



- ▲ The mains voltage may only be changed by qualified personnel.
- ▲ Before the fuse and mains voltage are changed, the device must be disconnected from the mains and remove the mains plug. See paragraph 3.1.4.
- ▲ The fuse may only be replaced by the indicated fuse type.

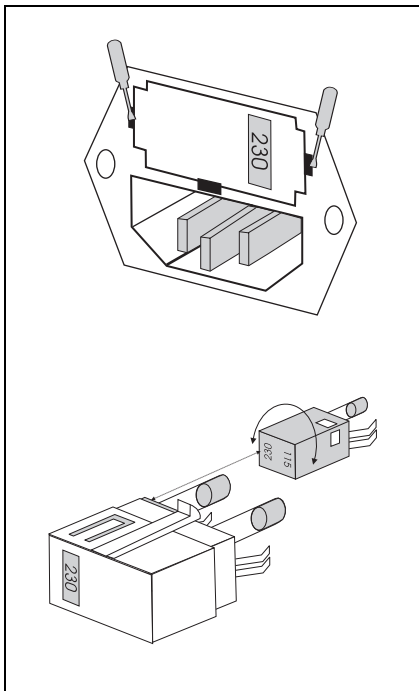

Fig. 6.1 Fuse inset

Changing the fuse

1. Disconnect the device from the mains and remove the mains plug. See paragraph 3.1.4.
2. Loosen the fuse inset using a screwdriver and remove it.
3. Replace existing fuses with the same type
250 VAC 2 x 200 mA (T) or 115 VAC 2 x 315 mA (T)
4. Reinsert the fuse inset.

Changing the mains voltage

1. Disconnect the device from the mains and remove the mains plug.
See paragraph 3.1.4.
2. Loosen the fuse using a screwdriver and remove it.
3. Remove the grey inset, turn it by 180° and reinsert it.
4. Check the voltage indication in the window.
5. Replace both fuses.
For:
 - 250 VAC with 2 x 200 mA (T)
 - 115 VAC with 2 x 315 mA (T)
6. Reinsert the fuse assembly.

6.5 Cleaning

6.5.1 Cleaning the Casing



- ▲ Switch the unit off before cleaning and disconnect the mains. Do not, under any circumstances, immerse the apparatus into a cleaning liquid or sterilise with hot water, steam, or air.

The casing of the P8000 can be cleaned with a soft damp cloth on the surface only. Where necessary a domestic non-caustic cleaner can be used for grease and finger marks.

6.5.2 Cleaning the Patient Cable

The patient cable must not be exposed to excessive mechanical stress. Whenever disconnecting the leads, hold the plugs and not the cables. Store the leads in such a way as to prevent anyone stumbling over them or any damage being caused by the wheels of instrument trolleys.

The cable can be wiped with soapy water. Sterilization, if required, should be done with gas only and not with steam. To disinfect, wipe the cable with hospital standard disinfectant.

6.5.3 Cleaning the Thermal Print Head

If the printer is used a lot, a residue of ink from the grid on the paper can build up on the print head. This can cause the print quality to deteriorate. We recommend therefore that every month the print head is cleaned with alcohol as follows:

Extend the paper tray and remove paper. The thermal printhead is found under the paper tray.

With a tissue dampened in alcohol, gently rub the printhead to remove the ink residue. If the printhead is badly soiled, the colour of the paper grid ink (i.e. red or green) will show on the tissue.

6.6 Replacing the Recording Paper

The recording paper must be replaced as soon as the end of the paper is indicated by a red stripe on the lower edge. After the indication first appears, there are about 8 pages left. However, we recommend that the paper be replaced immediately. If no paper is left, the printing process is interrupted and a warning is given on the screen. To replace the paper proceed as follows:

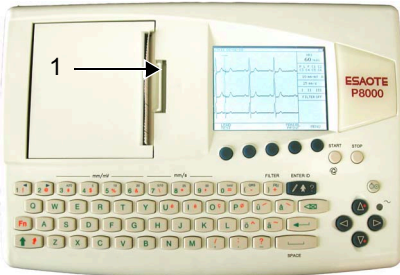

1. Press the locking catch (1) to the right. Open the printer door opens upward.
2. Remove any remaining paper from the paper tray.

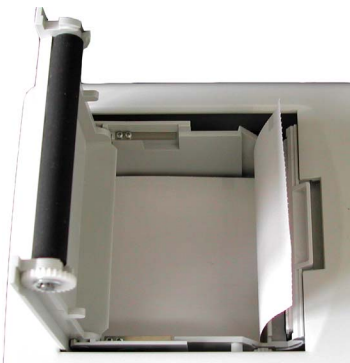

3. Place the beginning of the paper over the black paper roller.
4. Close the cover. Be sure that the paper lies exactly between the rails.
5. Press the STOP key to transport the paper to the start position.



ESAOTE can only guarantee perfect printouts when ESAOTE original chart paper or chart paper of the same quality is used.

6.6.1 Thermal Paper Handling

The thermal paper used in the P8000 requires slightly different handling to normal paper as it can react with chemicals and to heat. However, when the following points are remembered, the paper will give reliable results:

The following points apply to both storage, and when archiving the results.

1. Before use, keep the paper in its original cardboard cover. Do not remove the cardboard cover until the paper is to be used.
2. Store in a cool, dark and dry area.
3. Do not store near chemicals e.g. sterilisation liquids.
4. In particular do not store in a plastic cover.
5. Certain glues can react with the paper - do not attach the printout onto a mounting sheet with glue.

6.7 Fault-Finding

Error	Cause	Remedy
Unit does not switch on, Blank Screen	<ul style="list-style-type: none"> No mains supply, Green mains indicator off Contrast wrong adjusted Mains supply ok, but the screen is still not lit 	<ul style="list-style-type: none"> → Check mains supply → Check contrast. Press the function key (FN) and then the UP/DOWN cursors keys to change the contrast. → Press the OFF key. Wait a few seconds and switch on again. → If the screen is still not lit: Call your local ESAOTE representative.
QRS traces overlap	<ul style="list-style-type: none"> Wrong settings Bad electrode 	<ul style="list-style-type: none"> → Change sensitivity setting → Ensure that the automatic sensitivity reduction is not switched off. → Reset signals to baseline - press the 1mV key → Check electrode contact - Replace electrodes → If traces still overlap: Call your local ESAOTE representative. <p>Note: Some patients have very high amplitudes and even on the lowest sensitivity settings, the QRS traces can overlap.</p>
'Noisy' traces	<ul style="list-style-type: none"> Bad electrode Patient not relaxed Wrong setting 	<ul style="list-style-type: none"> → Check electrode contact → Reapply electrodes → Ensure that the patient is relaxed and warm → Check all filter settings. → Activate Myogram filter - change cutoff frequency → Ensure mains filter is correct for mains supply → If the trace is still 'noisy': Call your local ESAOTE representative.
No printout obtained after an auto mode recording	<ul style="list-style-type: none"> No paper Wrong settings 	<ul style="list-style-type: none"> → Ensure that paper is loaded. → Check Settings - ensure that at least one item is selected for print after an auto ECG is recorded → If the printer still doesn't work: Call your local ESAOTE representative.
Printout fades or is not clear	<ul style="list-style-type: none"> Old paper inserted Wrong inserted paper Dirty print head 	<ul style="list-style-type: none"> → Ensure that fresh ESAOTE paper is installed. → Note that the thermal paper used for the P8000 is heat and light sensitive. If it is not stored in its original seal, stored in high temperatures or is simply old, print quality can deteriorate. → Ensure that the paper has been installed correctly with the paper mark at the top. → Over a period of time, the printing ink from the grid on the paper can form a film on the thermal print head. Clean the thermal print head with a clean cloth as described previously. → If the problem persists call your local ESAOTE representative.
No printout of interpretation statement or measurements	<ul style="list-style-type: none"> Wrong setting 	<ul style="list-style-type: none"> → Check that the interpretation and measurement options are enabled for the printout.
No key response, LCD locked	<ul style="list-style-type: none"> Software hang up 	<ul style="list-style-type: none"> → Switch off, and switch on again after a few seconds. → If the unit is still not working call your local ESAOTE representative.

6.7.1 Accessories and Disposables



- ▲ Always use ESAOTE replacement parts and disposables, or products approved by ESAOTE. Failure to do so may endanger life and invalidate the guarantee.

Your local representative stocks all the disposables and accessories available for the P8000. A full list of all ESAOTE representatives can be found on the ESAOTE website (www.ESAOTE.com). In case of difficulty contact our head office. Our staff will be pleased to help process your order or to provide any details for all ESAOTE products.

7 Technical Data

7.1 System

Dimensions	290x 198 x 76 mm, approx. 2.6 kg
Built-in monitor	76 x 57 mm effective display area, 320 x 240 dots resolution
Power supply	
Mains Voltage	• 220 - 240 V (nominal), 50 / 60 Hz; 110 - 115 V (nominal), 50 / 60 Hz;
Power consumption	• Max. 28VA
Battery	• Operation with built-in rechargeable battery
Battery	Lead acid 12 V
Capacity	• 3 hours normal use (every 10 min printout 10 pages)
Battery Life	• 6 hours Standby
Recharging time	• Under normal operating conditions, 4 years
	• 90 %: approx. 7 hours, 100 %: approx. 15 hours
Line frequency filter	Distortion-free suppression of superimposed 50 or 60 Hz sinusoidal interferences by means of adaptive digital filtering
Printer	High-resolution thermal head printer, 8 dots/mm (amplitude axis), 40 dots/mm (time axis) @ 25 mm/s
Frequency range	• 0.05 ... 150 Hz (IEC/AHA)
Chart paper	• Thermo-reactive, Z-folded, 72 mm wide
Interfaces	RS-232 interface for data transmission to PC (ArchiMed Data Management SW) and external modem connection; parallel port for external printer
Memory (option)	Storage for up to 40 ECG recordings
Environmental conditions	
Operating temperature,	• 10 ... 40 °C
Storage temperature,	• -10 ... 50 °C
Relative humidity	• 25 ... 95 % (no condensation)
Pressure during operation	• 700 ... 1060 hPa

7.2 Technical Data for ECG

Patient input circuit	Fully floating and isolated, defibrillation-protected (only with original ESAOTE patient cable)
Leads	<ul style="list-style-type: none"> • 12 simultaneous leads • Standard • Cabrera
Monitor display	
Leads	<ul style="list-style-type: none"> • 3-channel display of the selected leads <ul style="list-style-type: none"> – selectable speed of 25, 50 mm/s – selectable amplitude 5, 10, 20 mm/mV
Status	<ul style="list-style-type: none"> • Filter status (on/off) • Insufficient electrode contact • Heart Frequency, HF
ECG Printout	
Chart print-out speed	<ul style="list-style-type: none"> • 5/10/25/50 mm/s (manual print)
Sensitivities	<ul style="list-style-type: none"> • 5/10/20 mm/s, either automatically adjusted or manually selected
Recording track	<ul style="list-style-type: none"> • 3-channel presentation, optimal positioning on a width of 72 mm, automatic baseline adjustment
Automatic lead programs	<ul style="list-style-type: none"> • 3/12-channel presentations of 12 simultaneously recorded standard leads Numerous print-out formats can be selected.
Data record	<ul style="list-style-type: none"> • Patient data (name, age, height, weight, BP), user ID • Listing of all ECG recording conditions (date, time, filter)
With optional interpretation (C) program	<ul style="list-style-type: none"> • ECG measurements results (intervals, amplitudes, electrical axes) • average complexes with optional measurement reference markings • guidance on interpreting adult and paediatric ECG's
Filter	
Myogram filter (muscle tremor filter)	25 Hz or 35 Hz, can be switched on/off
ECG amplifier	Simultaneous recording of all 9 active electrode signals (= 12 leads)
Sampling frequency	<ul style="list-style-type: none"> • 1000 Hz
Resolution	<ul style="list-style-type: none"> • 5 μV / 12 bit
Pacemaker detection	<ul style="list-style-type: none"> • $\geq \pm 2$ mV / pulse widths ≥ 0.1 ms
Frequency range	<ul style="list-style-type: none"> • 0.05 ... 150 Hz (IEC/AHA)
Measurement range	<ul style="list-style-type: none"> • dynamic ± 10 mV, DC ± 300 mV
CMRR	<ul style="list-style-type: none"> • > 100 dB
Input Impedance	<ul style="list-style-type: none"> • 100 MΩ
Defibrillation protection	<ul style="list-style-type: none"> • 5000 VDC

7.3 Safety Standards

Safety standard

IEC/EN 60601-1
IEC/EN 60601-2-25

EMC

IEC/EN 60601-1-2

Protection class

I according to IEC/EN 60601-1 (with internal power supply)

Conformity

CE according Directive 93/42/EEC IIa

Protection

This device is not designed for outdoor use (IP 20)

8 Index

A

Abnormal ECG 36
Accessories and Disposables 51
Age Assumed to be 36
Auto Mode recording 11
Auto Sensitivity 27
Auto-Centering 37
Automatic Format 1 and 2 34
Automatic Mode 25
Auto-Storage 37
Average Cycles 34

B

BASE INIT 44
Baseline filter 35
Baseline Stabiliser 35
Battery
 Battery Life 52
 Capacity 52
Battery disposal 46
battery symbol 15
Baudrate 40

C

C = Interpretation 41
Changes setting 31
Changing the fuse 47
Changing the mains voltage 47
Charging the battery 46
Charging time 46
Chart Speed 28
Cleaning 48
Colour Code 22
Communication 40
Communication (RS-232) Tes 45
Communications Test 43
Confirm the setting 31
Connecting AT-101 14

D

Date and Time 39
Default Settings 44

E

ECG Printout 33, 34
ECG Settings 32
ehb (D, A, J) 37
electrode indication 23
Electrode Placement 18
Entering Patient Data 17

F

Fault-Finding 50
Filters 35

H

highlight all recordings 29

I

Inserting printing paper 16
Installing New Software Options 43
Installing New Software Options (Upgrade) 43
Interpretation 33, 34, 36

K

Keypad 11

L

Languag 39
LCD Screen 13
Lead Group 27
Lead Sequence 37
Lead Test 23
Leads 37
Left Posterior (V4-V9) 37
Line Transmission 30

M

M = Memory 41
Mains filter 35
Maintenance interval for the battery 46
Manual Mode 26
Markings 33, 34
Measurement 33, 34
Memory 29
Mode 40
Modem Init. 40
Modem Transmission 30
Monthly Check 45
Myogram Filter 28
Myogram filter 35

N

Navigation with Softkeys 31
Nehb Leads 20

P

Paper Mode 39
patient data key. 17
Phone No. 40
Potential Equalisation 15
Print Setup 42
Print Setup Menu 42
PRINT SETUP softkey 42

Q

QRS Beep 28

R

Recentering 28

Replacing the Recording Paper 49
Rhythm Leads 1 33, 34
Rhythm Leads 2 33, 34
Right Precordials (V5r) 37
Right Precordials (V6r) 37

S

Screen (and Manual Printout) Settings 27
screen contrast. 16
Select desired parameters 31
Self-test 45
Sensitivit 27
Sensitivity 36
Setup 31
Signals 37
Skin/Electrode Resistance 23
Smoothing Filter 35
Softkeys 11
STOP printout 11
System Settings 38

T

Technical Data 52
Test and Information 41
Thermal Paper Handling 49
To confirm a setting 31
Transmitting the Recordings 30

U

Unconfirmed Report 36
Unit 39
Unit Defaults Table 44
Update the Software 43
Upgrade 43
User Identification (User ID) 39

